

**This Page Is Inserted by IFW Operations
and is not a part of the Official Record**

BEST AVAILABLE IMAGES

Defective images within this document are accurate representations of the original documents submitted by the applicant.

Defects in the images may include (but are not limited to):

- **BLACK BORDERS**
- **TEXT CUT OFF AT TOP, BOTTOM OR SIDES**
- **FADED TEXT**
- **ILLEGIBLE TEXT**
- **SKEWED/SLANTED IMAGES**
- **COLORED PHOTOS**
- **BLACK OR VERY BLACK AND WHITE DARK PHOTOS**
- **GRAY SCALE DOCUMENTS**

IMAGES ARE BEST AVAILABLE COPY.

**As rescanning documents *will not* correct images,
please do not report the images to the
Image Problem Mailbox.**



(12) **EUROPEAN PATENT APPLICATION**

(43) Date of publication:
 31.01.1996 Bulletin 1996/05

(51) Int. Cl.⁶: **H04B 10/17, H01S 3/06**

(21) Application number: 95111505.4

(22) Date of filing: 21.07.1995

(84) Designated Contracting States:
AT BE CH DE DK ES FR GB IE IT LI LU NL PT SE

(72) Inventors:

- Meli, Fausto
 Piacenza (IT)
- Piciaccia, Stefano
 Milan (IT)

(30) Priority: 25.07.1994 IT MI941574
 14.07.1995 IT MI951535

(74) Representative: Giannesi, Pier Giovanni et al
 I-20126 Milano (IT)

(54) **Amplified telecommunication system for wavelength-division multiplexing transmissions capable of limiting variations in the output power**

(57) An optical telecommunication system comprising means (37, 38, 39, 40) for generating optical signals of different wavelengths, an optical-fibre line with amplifying means (45, 45', 45'', 45'''), a pre-amplifier (47), and receiving means (54, 55, 56, 57), wherein the pre-amplifier (47) comprises an optical waveguide (5, 7, 9) doped with a rare earth material, differential-attenuation means (8) located at a first position along the doped waveguide and capable of causing an attenuation in the signal band which is greater than the attenuation caused at the

pumping wavelength, and filtering means (6) located at a second position and adapted to attenuate by a value higher than a predetermined minimum, the spontaneous emission in a wavelength band contiguous with the signal band. The position and attenuation of the differential-attenuation means and filtering means and the wavelength band are selected in a functional relation with respect to each other in order to limit the output power variations from the pre-amplifier.

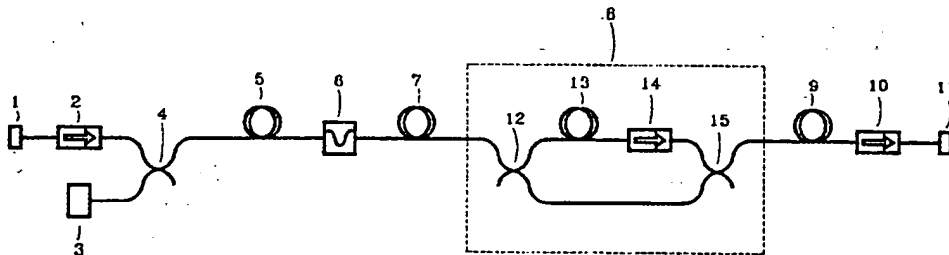

fig. 3

The principle on which operation of such an amplifier having a power limitation is based is illustrated with reference to Fig. 2 showing the course of the pumping power (expressed in mW on the ordinate on the left) and the signal level (expressed in dBm on the ordinate on the right) relative to the normalized fibre length (on the abscissa). Two cases are shown: an input signal of -25 dBm (a "weak" signal, in solid line) and an input signal of 0 dBm (a "strong" signal, in dotted line). The input pumping power is 20 mW. The equalizing action results from an equilibrium between the pump power and amplified signal power in the two stages, before and after the localized attenuation. In the first stage (fibre 4) the "strong" signal is amplified to a level higher than the weak signal. The "weak" signal, however, utilizes the pumping power less, the residual component of said power in the second stage (fibre 6) being sufficient to amplify the signal to the desired output level.

The "strong" signal, on the other hand, utilizes the pump energy in the first stage almost completely. Towards the end of the second stage the residual pumping power is very low and the signal is amplified to a small extent or even slightly attenuated so that it reaches the same level as the "weak" signal. The intermediate-level input signals between the two stated limits obviously develop in the same manner towards the same output level. By conveniently selecting the position of an absorber 5 along the fibre such an amplifier ensures signals having a constant output level within 1 dB in the presence of input signals having a variable level within an interval of at least 15 dB.

The device described in EP567941 to be used in the cases in which an optical amplifier having a strong compression of the signal dynamics is required, is convenient for employment as a pre-amplifier in a point-to-point communication system, that is free of intermediate amplifiers along the fibre connecting a transmitter and a receiver. In this case the device is fitted between the passive connecting fibre and the receiver.

The US Patent 5280383 to J.F. Federici et al, discloses a two-stage optical amplifier capable of operating at a reduced pumping power. The first stage operates under linear amplification conditions, the second stage under saturation conditions, so as to cause a certain compression of the signal dynamics. In one of the embodiments the two stages are separated by an isolator which may be followed by a filter having a passband of about 10 nm. The isolator removes the counterpropagating amplified spontaneous emission, whereas the bandpass filter removes part of the propagating amplified spontaneous emission in the signal direction, allowing the selected 10 nm band to pass. Unlike the amplifier described in EP567941, however, each stage has an independent pumping source and the bandpass filter absorbs any residual pump power from the first stage. Therefore this amplifier is not based on the described mechanism involving a differential pump absorption (depending on the signal level) in the first stage and residual-pump exploitation (in the case of weak signals) in the second stage, which is utilized in the amplifier described in EP567941. In the presence of a filter, in addition, this amplifier can operate only in a transmission band restricted to less than 10 nm, insufficient for a wavelength-division multiplexing transmission.

Article "REAP: Recycled Erbium Amplifier Pump", by J.-M.P. Delavaux et al, published in IEEE Photonics Technology Letters, vol. 6, No. 3, March 3, 1994, pages 376-379 describes a two-stage pre-amplifier having an erbium-doped fibre, utilizing in the second stage the residual pump power from the first stage, wherein the use of an optical isolator in series with a bandpass filter with a bandwidth of 6 nm (-1 dB) between the two stages of the device enables a high gain to be achieved as well as a low noise figure for a signal of a wavelength included within the transmission band of the filter, in addition to a certain compression of the signal dynamics. In particular, by restricting the transmission band of the device to the filter passband, the spontaneous emission to the other wavelengths is removed, so that it does not degrade the reversing condition of the first stage or saturate the second stage. The above article relates to the transmission of a single channel with a wavelength within the filter transmission passband. Nowhere in the article possible applications of the device in a WDM optical telecommunication system is suggested.

For the purpose of achieving a multi-wavelength transmission, the Applicant has tried to use the device described in EP567941 as the preamplifier at the end of a WDM transmission line with cascade amplifiers as described in IT/M194A000712. However the expected compression of the signal dynamics between the input and output was found to occur to a reduced extent only: in the case of a 20 dB variation in the input signal level, a 14 dB variation was obtained in the output signal level, which variation is greater than that allowed by the above standards.

This drawback is deemed to be connected with the spontaneous emission and the effect of the amplification thereof on the pumping energy absorption in the two stages of the device. In the case of an optical WDM telecommunication, at the exit of the wide-band transmission line with cascade amplifiers, a spontaneous-emission component is present close to the signals at different wavelengths, which is distributed according to a continuous spectrum, typical of the type of amplifying fibres employed along the transmission line. The amplified signal level is higher than the level of the spontaneous emission at the respective wavelength and this ensures a signal/noise ratio sufficiently high to enable a faultless reception. The overall power of the spontaneous emission, however, is connected with the intensity of the transmitted signals. Weak signals are amplified along the line with a moderate exploitation of the energy supplied by the pump, so that most of this energy amplifies the spontaneous emission. Stronger signals empty to a greater degree the levels excited by the pump and the available energy for a spontaneous emission and amplification thereof is smaller. In addition to depending on the level of the transmitted signals, the spontaneous emission grows on growing of the number of the amplifying stages connected in cascade.

The filtering means is inserted along the doped waveguide preferably at a position between 15% and 50% of the overall length of said waveguide, more preferably between 20% and 30%.

Preferentially, the differential-attenuation means is inserted along the doped waveguide between the filtering means and the exit, in particular at a position between 50% and 75% of the overall length of the waveguide.

5 Second filtering means may be provided which is adapted to transmit the signals without attenuating them to an important degree and to attenuate the spontaneous emission at least at one wavelength band contiguous to that of the signals. This second filtering means is advantageously located along said doped waveguide between 50% and 75% of the overall length of the waveguide.

10 The doped optical waveguide is preferentially a silica-based optical fibre and the rare earth material used as the main dopant is preferably erbium. As the secondary dopants, aluminium, germanium and lanthanum or aluminium and germanium may be advantageously used. The filtering means preferably have a cut-off wavelength (at -3dB) included between 1532 and 1534 nm. Said wavelength band of the signals preferentially comprises the band between 1535 and 1560 nm.

15 The filtering means may consist of a portion of optical fibre having two cores optically coupled to each other for wavelengths in the spontaneous emission band contiguous to the signal band, with one of the two cores which is coaxial with the fibre and connected at the two ends to the doped waveguide and with the other core which is off-centre and cut off at the ends. Alternatively, the filtering means may advantageously consist of an interferential filter used in reflection. The filtering means may also comprise a preferential low-attenuation path for the pump wavelength. For example, said filtering means may comprise: a first dichroic coupler separating the radiation in the signal and spontaneous-emission
20 band (to a first terminal) from the radiation at the pump wavelength (to a second terminal); a filter, connected to the first terminal and capable of attenuating the spontaneous emission; a second dichroic coupler combining the radiation from the filter with the radiation at the pump wavelength from the second terminal. The attenuation of said filtering means in the wavelength band contiguous to the predetermined signal band is preferably of at least 6 dB, more preferably of at least 10 dB.

25 The differential-attenuation means advantageously consists of: a first dichroic coupler separating the radiation in the signal band (to a first terminal) from the radiation at the pump wavelength (to a second terminal); an attenuating component, in particular an optical fibre, connected to the first terminal, capable of attenuating signals; a second dichroic coupler combining the radiation from the attenuating element with the radiation at the pump wavelength from the second terminal. An optical isolator can be inserted between the attenuating component and the second dichroic coupler.

30 The differential-attenuation means may also be comprised of a winding having a predetermined bending radius and consisting of one or more turns of optical fibre, optionally a portion of the same doped optical fibre used for the amplifier.

Preferentially, the attenuation of the differential-attenuation means in the signal band is greater than the attenuation at the pump wavelength by an amount of 5 ± 1 dB.

35 The optical telecommunication system according to the invention is particularly advantageous in the case in which the amplifying means consists of three or more active-fibre optical amplifiers disposed in cascade along the optical-fibre connecting line. In the case of cascade amplifiers, in fact, the problem of a spontaneous-emission accumulation along the line is particularly felt, above all with a wideband transmission, which problem is coped with and solved by the system according to the present invention.

40 The optical amplifying means may comprise a silica-based active fibre, having a core doped with at least one fluorescent main dopant and at least one secondary dopant, in such a functional relation with respect to each other that they provide an optical signal/noise ratio at the reception, measured with a 0.5 nm filter amplitude, which is not lower than 15 dB for signals of a wavelength included in said predetermined band when the input signal power at each of said active-fibre optical amplifiers is not lower than -16dBm. Advantageously said main dopant is erbium and said secondary dopants are aluminium, germanium and lanthanum.

45 According to a second aspect, the present invention relates to an optical amplifier comprising:

- a rare-earth-doped optical waveguide,
 - input means for one or more signals included in a predetermined wavelength band and a predetermined range of input powers,
 - 50 - pumping means for said doped waveguide, adapted to provide optical pumping power at a pumping wavelength,
 - coupling means within said doped waveguide of said optical pumping power and said input signal or signals,
 - output means emitting at a given output level, one or more output signals amplified by the stimulated emission of said rare earth material submitted to pumping in said doped waveguide,
 - differential-attenuation means located in a first predetermined position along the active waveguide, capable of supplying a predetermined attenuation having a value at said predetermined wavelength band which is different from
55 the attenuation supplied at said pumping wavelength,
- characterized by filtering means located at a second predetermined position along said doped waveguide and provided with a spectral attenuation curve adapted to transmit the signals at said predetermined wavelength band without attenuating them to an important degree and to attenuate by a value higher than a predetermined minimum

a compression of the output signal dynamics with respect to the input signal dynamics. Signals are then transmitted through an isolator 10 to an output terminal 11.

As the active fibre, a silica-based fibre doped with Er/Al/Ge/La of the type described in the Italian Patent application MI94A000712 has been used, the core having the following composition expressed in percent content by weight of oxide:

5 Er₂O₃: 0.2% Al₂O₃: 4% GeO₂: 18% La₂O₃: 1%

Such a fibre had a numerical aperture of 0.219 and a cut-off wavelength of 911 nm. The emission curve of this type of fibre is reproduced in Fig. 4 which has been obtained by using a 11 m long fibre submitted to pumping at 980 nm with a pump power transmitted to the fibre of about 60 mW. The selected length for the fibre corresponds to an efficient utilization of the adopted pump power. As can be seen from the figure, this fibre has a spontaneous emission with a peak at 1530 nm.

The filtering means is preferably disposed along the waveguide at a location different from the waveguide entry. Thus the filtering means can remove not only the spontaneous emission from the transmitting line, but also part of the spontaneous emission generated along the waveguide and in this way prevent the amplification of the spontaneous emission from using up the available pump energy thereby impairing the device ability to amplify weak signals. Positioning of the filtering means at the waveguide entry would increase the input losses, worsening to the same extent the noise figure at the wavelength of operation of the filter.

In accordance with the above, the filter position is therefore selected for the purpose of causing said filter to eliminate or attenuate both the spontaneous-emission peak contiguous to the signal band and progressively formed along the line, and an important fraction of the peak of the spontaneous emission generated in the first portion of the amplifier, so as to make the above described compression mechanism efficient, without on the other hand adversely affecting the signal when it is of a low intensity.

In the described structure a convenient position for filter 6 is between 15% and 50%, and preferably between 20% and 30% of the overall length of the active fibre of the amplifier.

The position of the differential attenuator 8 may be selected based on the criteria described in the above mentioned patent application EP567941, in particular between 50% and 75% of the overall length of the active fibre.

A person skilled in the art, in the presence of specific features of the employed system and devices will be able to select the most appropriate locations, case by case, in order to accomplish the operating mechanism of the invention, as described.

In the example shown, the fibre portions 5, 7 and 9 have been selected with a length of 3, 5 and 5 m respectively, corresponding to a positioning of the filter 6 and differential attenuator 8 approximately at 23% and 62% respectively of the overall length of the doped fibre.

The notch filter 6 is of the type having an optical fibre portion with two cores optically coupled to each other at a preselected wavelength, one of them being coaxial with the connected optical fibres and the other off-centre and cut off at the ends, as described in patents EP441211 and EP417441 in the name of the same Applicant, the description of which is herein incorporated by reference. Said filter is such sized that it couples in the off-centre core a band of wavelengths, corresponding to the spontaneous-emission peak of the doped fibre, contiguous with the transmission band of the signals; cutting-off at the ends of the off-centre core enables the wavelengths transferred thereinto to be dispersed in the fibre cladding, so that they are no longer recoupled in the main core.

In the experiment carried out, a two-core fibre of the described type has been used; it is a silica-based germanium-doped fibre having the following parameter values:

attenuation at 1530 nm	6 dB
wavelength corresponding to a 3 dB attenuation	1533 nm
filter length	35 mm
distance between the cores	18 μm
diameter of the centre core	4 μm (NA 0.195)
diameter of the off-set core	9 μm (NA 0.135)

The spectrum response curve of the two-core filter is reproduced in Fig. 5.

difference in the output level between the signals at different wavelengths, that is the different height of the signal peaks, that is found in both cases, is attributable to the different amplification factor at the different wavelengths of the transmission line with the optical amplifiers 45. However, this difference does not affect the signal/noise ratio, that is the transmission quality. The level of the individual signals in the case of use of the amplifier provided with filter, on the contrary, remained almost the same as in the case without filter. The positions on the Y-axis of lines C and D in the two figures show the highest and lowest output levels of the four test signals, respectively with $\lambda_4 = 1556$ nm and $\lambda_1 = 1536$ nm. The signal at λ_4 had an output level of 2.6 dBm in the case without filter (figure 7A) and 3.5 dBm in the case with filter (figure 7B), whereas the signal at λ_1 had an output level of -7.1 dBm in the case without filter and -8.3 dBm in the case with filter. In addition, it is possible to note that, as expected, the spontaneous emission with a wavelength close to the peak at 1531 nm was greatly attenuated in the presence of the notch filter as compared with the case free of filter.

Experiment 3

If we compare Figs. 8A and 8B, we can appreciate the superiority of the amplifier according to the invention with respect to the device of the known art. Said figures are obtained in an experimental situation similar to that of experiment 2, with the only difference residing in the attenuation value of the variable attenuators 46 of Fig. 6 that for the new test was fixed to 28 dB for each of the attenuators. By selecting this value, simulation was done of the conditions of the strongest attenuation provided for operation of an optical communication line of the type described in IT/M194A000712, as a result of localized attenuations along the fibres, attenuations due to the fibre aging or loss of amplification in the optical amplifiers. These conditions correspond to "weak" signals at the amplifier entry. Fig. 8A relating to the case in which the notch filter is absent, shows signal output levels included between -8.3 dBm ($\lambda_1 = 1536$ nm, line C) and -12.9 dBm ($\lambda_2 = 1544$ nm, line D). Figure 8B, obtained in the configuration provided with the filter, shows on the contrary output levels included between -3.7 dBm (λ_1 , line C) and -7.2 dBm (λ_2 , line D), which are much closer (as compared with the case of Fig. 8A) to the output levels reached under low attenuation conditions (that is in the case of "strong" signals entering the amplifier). In this case too the effect of the notch filter can be found in the spontaneous-emission band contiguous to the signal band, which is greatly attenuated in the spectrum of Fig. 8B as compared with that of Fig. 8A. By comparing Figs. 7B and 8B, relating to the experimental configuration of respectively "strong" and "weak" input signals, it is possible to see that in the first case the peak of the spontaneous emission has reached a reduced level with respect to the signals and in the second case a level comparable to the signals. The amplifier ensured a sufficiently high output level even in the case of "weak" input signals overlapping the spontaneous emission.

Experiment 4

By a systematic series of tests, carried out varying the signal input level, data reproduced in Figs. 9A and 9B were reached. These data show the greater compression of the signal dynamics reached with the amplifier of the invention, as compared to the known device according to the prior art. The curves reproduce the course of the signal power from the amplifier depending on the input signal power, for each of the four test wavelengths, both in the case in which the amplifier 47 is provided with a notch filter (Fig. 9B) and in the case of an amplifier free of filter (Fig. 9A). It will be noted that the output power variation is reduced to an important extent in the case of the device of the invention. In particular, by causing the variation of the input signal power in the range between -35 dBm and -12 dBm, a maximum difference of 9 dB between the highest (+3 dBm) and lowest (-6 dBm) output powers measured at one of the wavelengths ($\lambda_4 = 1556$ nm) was reached in the case of the amplifier provided with a notch filter (Fig. 9B). In the case of the amplifier free of filter (Fig. 9A), the maximum difference between the end powers (+3 dBm and -11 dBm, respectively) was 14 dB under the same conditions for the input signals.

It will be recognized that the power values from the amplifier, in the case of use of a notch filter, are higher than expected for a preamplifier having the above specified standards. However, taking into account the attenuation given by components such as a demultiplexer (6 dB in the case of four channels) and the filters (about 3 dB over each channel) that will have to be interposed between the pre-amplifier and the receiver, an additional attenuator of about 7 dB can be sufficient to bring the output powers back within the required range from -25 dBm to -13 dBm, without the quality of the reception being impaired.

The use of a filter 6 having a stronger attenuation at the spontaneous-emission peak and/or a greater slope in the spectral response curve can lead to a more efficient removal of the spontaneous emission and a greater compression of the signal dynamics.

In particular, the notch filter 6 can be an interferential filter. Available on the market are interferential filters operating as bandpass filters in transmission and notch filters on reflection. In particular, model WD1530 TF1 produced by JDS

A two-stage optical line amplifier according to the present invention, adapted for use in an optical wavelength division multiplexing telecommunication system, will be described with reference to Fig. 12.

In particular, this amplifier provides two stages, differential attenuation means and filtering means being located along the first of the two stages so as to achieve globally the above mentioned gain compression.

5 The description will reference a line amplifier which is adapted, particularly as to the number of communication signals, for use in an optical telecommunication system of the type of the one described with reference to Fig. 11, instead of line amplifiers 45, 45', 45", 45'''. However, the number of the simultaneously amplified signals is not limited to four, as in the description, and is constrained only by the need of keeping the gap between their wavelengths higher than a minimum value, depending from the particular features of the adopted system. In case of need the line amplifier can be adapted by a person skilled in the art according to specific features of the telecommunication systems where it has to be used.

10 The first stage of the device will be referred to as 140. In it, a first dichroic coupler 103 feeds the communication signals coming from an input 101 through a first optical isolator 102 and the pumping radiation coming from a first optical pumping source connected to the dichroic coupler 103, to a first section 105 of rare earth doped active optical fibre, whose end connects to a second dichroic coupler 106.

15 The dichroic coupler 106, like the previous dichroic coupler 103, is of the type adapted for combining into a common output a radiation at the pumping wavelength and a radiation at the wavelength of the communication signals, fed into two different inputs, and respectively adapted for dividing towards two separated outputs the pumping radiation and the communication signals fed into a common input.

20 One output of the dichroic coupler 106 ends in one input of a dichroic coupler 117 of the same type as the previous ones, so as to establish a low attenuation path for the pumping radiation.

An attenuating and filtering optical circuit 130 is connected between another output of dichroic coupler 106 and another input of dichroic coupler 117. It includes an optical circulator 109, to a first port 107 of which it is connected an output of dichroic coupler 106; an attenuating fibre 110 and selective reflection filters 111, 112, 113, 114, followed by a low-loss termination 115 are cascade coupled to a second port 108 of the same optical circulator. A third port 116 of the optical circulator 109 is connected to the dichroic coupler 117.

The output of this dichroic coupler ends in a second section 118 of rare earth doped active optical fibre, followed by a second optical isolator 119.

The isolator 119 links the first stage of the device to the second stage 150.

30 The second stage comprises a third section 120 of rare earth doped active optical fibre, a first end of which is fed with the communication signals coming from the first stage through the isolator 119. The pumping radiation coming from a second pumping source 122 is fed into active fibre section 120 through a fourth dichroic coupler 121, connected to a second end of active fibre section 120, opposite to said first end. The communication signals go, through dichroic coupler 121, to a third optical isolator 123, connected to it, and from there to an output 124.

35 The active optical fibre is preferentially a silica based optical fibre. The rare earth used as the main dopant is preferably erbium. As the secondary dopants, aluminium, germanium and lanthanum or aluminium and germanium may be advantageously used. As the active fibre a fibre can be used of the type of that shown in the cited patent application IT/MI94A0007.12 and previously described.

40 The corresponding previously described devices can be used also for dichroic couplers 103, 106, 117, 121 and for isolators 102, 119, 123.

Pumping sources 104 and 122 can for example be Quantum Well lasers. In particular, source 104 can be of the type already described with reference to the amplifier of the Fig. 3, while for source 122 a maximum optical output power of about 80 mW at the wavelength of 980 nm is foreseen.

45 By "filter with selective reflection at the wavelength λ of one of the communication signals in a wavelength division multiplexing optical communication system" it is intended an optical component that is capable of reflecting a substantial fraction of the radiation with wavelength in a predetermined wavelength band and of transmitting a substantial fraction of the radiation with wavelength outside said band, wherein said wavelength band includes the wavelength λ and excludes the wavelengths of the other communication signals.

50 The output of selective reflection filter 114 (the one located at the greatest distance from the optical circulator) needs to be conveniently terminated, in order to avoid spurious reflections towards the optical circulator. To this end one of the techniques known to the skilled in the art may be adopted, for example the termination by an angled, low-reflection optical connector 115. A convenient connector is, e.g., model FC/APC, produced by SEIKOH GIKEN, 296-1 Matsuhidai, Matsudo, Chiba (JP).

55 The optical connections between the various components of the optical circuit of the line amplifier may be carried out by one of the known techniques, e.g. by fusion splicing. The optical connections between selective reflection filters 111, 112, 113, 114 may also be achieved by optical connectors, preferably of the low-reflection type, so as to allow an easy addition or removal of filters with different wavelengths.

Alternatively, it is possible to form all selective reflection filters 111, 112, 113, 114 on a single section of optical fibre, by the techniques described in the following; the optical fibre section is then connected to port 108 of the optical circulator.

A localised attenuation for the communication signals may be achieved also by using components with limited reflectivity at the signal wavelength as selective reflection filters 111, 112, 113, 114. Distributed Bragg reflection optical fibre filters can be manufactured e.g. with a reflectivity lower than the cited maxima.

The described line amplifier has a two stage structure.

5 The first stage 140 consists of two optical fibre sections, divided by dichroic couplers 106, 117 and by optical circuit 130. It removes the spontaneous emission and compresses the signal dynamics. A variation not higher than about 6 dB in the power of one of the communication signals at the output of the first stage has been evaluated in the case of a change of 20 dB in the input power of the signal.

10 The second stage 150 amplifies the signals to a sufficient power for transmission through the passive fibre following the amplifier. Thanks to the high degree of saturation of the active fibre 120, the second stage further contributes to compress the signal dynamics. The Applicant has measured, in an amplification stage with the specifications of the second stage 150, a variation in the output power not higher than 0.1 dB for each dB of change in the input power of the second stage, for any communication signal. The Applicant reckons that in a general case this variation is lower than 0.2 dB / dB.

15 The isolators 102, 119 and 123, set at the input and at the output of the two stages, reduce noise, particularly that due to counter-propagating spontaneous emission, to Rayleigh and Brillouin scattering and to the relative reflections along the communication line.

The optical circuit 130 filters the communication signals with respect to the spontaneous emission and, at the same time, selectively attenuates the communication signals with respect to the pump.

20 The selective attenuation causes, in accordance with the previously explained mechanism, a differential absorption of the pump in the two active fibre sections of the first stage of the described amplifier, in case of strong or weak input signals, from which a compression of the signal dynamics derives.

25 The presence of amplified spontaneous emission with wavelengths different from the communication signals has already been mentioned as a cause of low compression of the signal dynamics, even in the case of differential attenuation of the signals with respect to the pump.

In the just described line amplifier, this problem is solved by combining the operation of signal/pump differential attenuation with the operation of removing the spontaneous emission at the wavelengths different from those of the communication signals, both operations being performed by optical circuit 130 together with dichroic couplers 106 and 117.

30 In the described line amplifier, the spontaneous emission generated in the first section of active fibre and propagating in the signal direction is removed and does not propagate to the second section of active fibre.

Spontaneous emission is generated also along the second section 118 of active fibre of the first stage and along the active 120 of the second stage.

35 However, if more amplifiers of the type of the one described are cascade connected along a communication line, each of them receives as an input, in addition to the communication signals, only the spontaneous emission component generated in the previous line amplifier. The spontaneous emission accumulating along the line is limited. In particular, the power of the spontaneous emission with frequency ν present along the line after N_A amplifiers, is expressed by the following formula

$$40 \quad P_{ASE} = 2 h \nu n_{sp} \Delta \nu (G-1) N_A,$$

where h is the Planck constant, n_{sp} is the inversion level of the active fibre, G is the overall gain of the active fibre and $\Delta \nu$ is the overall bandwidth of the filtering means, that is, in the case of the invention, the sum of the bandwidths of the selective reflection filters associated with each communication signal.

45 Each of the line amplifiers according to the present invention compresses effectively the signal dynamics by the described mechanism, in the absence of spontaneous emission at its input with sufficient intensity to hinder the pump differential absorption in the two active fibre sections of the first stage.

50 The position of the optical circuit 130 with respect to the two active fibre sections of the first stage of the line amplifier can be chosen following the same criteria described in the cited patent application EP567941 to position the filtering means, and in particular between 50% and 75% of the overall length of the active fibre.

A person skilled in the art, in the presence of specific features of the employed system and devices will be able to select the most appropriate locations, case by case, in order to accomplish the operating mechanism of the invention, as described.

55 Fig. 13 shows the diagram of a two stage line amplifier according to an alternative version of the present invention. Components corresponding to the ones of the Fig. 12 have been allocated the same reference number: for their description reference is made to the previous description.

In the line amplifier shown in the Fig. 13 the first active fibre section 105 of the first stage 140 is pumped, in a direction opposite to signal propagation, by radiation from the pumping source 104, connected to an end of active fibre 105 by the dichroic coupler 106.

EP 0 695 050 A1

6. An optical telecommunication system according to claim 1, characterized in that said second predetermined position of said filtering means is located along said doped waveguide between 15% and 50% of the overall length of the waveguide.
- 5 7. An optical telecommunication system according to claim 6, characterized in that said second predetermined position of said filtering means is located along said doped waveguide between 20% and 30% of the overall length of the waveguide.
- 10 8. An optical telecommunication system according to claim 1, characterized in that said first predetermined position of said differential-attenuation means is located along said doped waveguide between 50% and 75% of the overall length of the waveguide.
- 15 9. An optical telecommunication system according to claim 1, characterized by the presence of second filtering means disposed along said doped waveguide and adapted to transmit the signals in said predetermined band without attenuating them to an important degree and to attenuate the spontaneous emission at least at one wavelength band contiguous to said predetermined signal band.
- 20 10. An optical telecommunication system according to claim 9, characterized in that said second filtering means is located along said doped waveguide between 50% and 75% of the overall length of the waveguide.
- 25 11. An optical telecommunication system according to claim 1, characterized in that said doped waveguide is a silica-based doped optical fibre.
12. An optical telecommunication system according to claim 11, characterized in that said rare earth material is erbium.
- 30 13. An optical telecommunication system according to claim 12, characterized in that said optical fibre is further doped with aluminium, germanium and lanthanum.
14. An optical telecommunication system according to claim 12, characterized in that said optical fibre is further doped with aluminium and germanium.
- 35 15. An optical telecommunication system according to claim 12, characterized in that said filtering means have a cut-off wavelength at -3dB included between 1532 and 1534 nm.
- 40 16. An optical telecommunication system according to claim 12, characterized in that said predetermined wavelength band comprises the wavelength band between 1535 and 1560 nm.
17. An optical telecommunication system according to claim 1, characterized in that said filtering means consists of a portion of optical fibre having two cores optically coupled to each other for wavelengths in said band contiguous to said predetermined band, with one of the two cores which is coaxial with the fibre and connected at the two ends to the doped waveguide and with the other core which is off-centre and cut off at the ends.
- 45 18. An optical telecommunication system according to claim 1, characterized in that said filtering means consists of an interferential filter used in reflection.
- 50 19. An optical telecommunication system according to claim 1, characterized in that said filtering means comprises:
- a first dichroic coupler separating the radiation in said predetermined band and said contiguous band to a first terminal and the radiation at said pumping wavelength to a second terminal;
 - a filter connected to said first terminal and capable of transmitting the signals in said predetermined band without attenuating them to an important degree and of attenuating the spontaneous emission in at least one wavelength band contiguous to said predetermined signal band;
 - a second dichroic coupler combining the radiation from said filter with the radiation at said pumping wavelength from said second terminal.
- 55 20. An optical telecommunication system according to claim 1, characterized in that the attenuation of said filtering means in said wavelength band contiguous to the predetermined signal band is at least 6 dB.

EP 0 695 050 A1

said first and second predetermined positions, said predetermined attenuation values of the differential-attenuation means, said predetermined attenuation minimum of the filtering means and said wavelength band contiguous to said predetermined band are selected in such a functional relation with respect to each other that power variations in one of the input signals within a range of 20 dB involve power variations in the output power from the amplifier included in a range not greater than 12 dB.

5

32. An optical amplifier according to claim 31, characterized in that said wavelength band contiguous to said predetermined signal band contains a relative maximum of the spontaneous emission of said optical waveguide doped with a rare earth material.
- 10
33. An optical amplifier according to claim 31, characterized in that power variations of one of the input signals to the pre-amplifier within a range of 20 dB involve variations of the output power from the amplifier in a range not greater than 9 dB.
- 15
34. An optical amplifier according to claim 33, characterized in that power variations of one of the input signals to the pre-amplifier within a range of 20 dB involve variations of the output power from the amplifier in a range not greater than 6 dB.
- 20
35. An optical amplifier according to claim 31, characterized in that said second predetermined position of said filtering means is located along said doped waveguide between 15% and 50% of the waveguide length.
36. An optical amplifier according to claim 35, characterized in that said second predetermined position of said filtering means is located along said doped waveguide between 20% and 30% of the waveguide length.
- 25
37. An optical amplifier according to claim 31, characterized in that said first predetermined position of said differential-attenuation means is located along said doped waveguide between 50% and 75% of the waveguide length.
38. An optical amplifier according to claim 31, characterized by the presence of second filtering means disposed along said doped waveguide and adapted to transmit the signals in said predetermined band without attenuating them to an important degree and to attenuate the spontaneous emission at least at one wavelength band contiguous to said predetermined signal band.
- 30
39. An optical amplifier according to claim 38, characterized in that said second filtering means is located along said doped waveguide between 50% and 75% of the overall length of the waveguide.
- 35
40. An optical amplifier according to claim 31, characterized in that said doped waveguide is a silica-based doped optical fibre.
41. An optical amplifier according to claim 41, characterized in that said rare earth material is erbium.
- 40
42. An optical amplifier according to claim 41, characterized in that said optical fibre is further doped with aluminium, germanium and lanthanum.
43. An optical amplifier according to claim 41, characterized in that said optical fibre is further doped with aluminium and germanium.
- 45
44. An optical amplifier according to claim 41, characterized in that said filtering means have a cut-off wavelength at -3dB included between 1532 and 1534 nm.
- 50
45. An optical amplifier according to claim 41, characterized in that said predetermined wavelength band comprises the wavelength band between 1535 and 1560 nm.
46. An optical amplifier according to claim 31, characterized in that said filtering means consists of a portion of optical fibre having two cores optically coupled to each other for wavelengths in said band contiguous to said predetermined band, with one of the two cores which is coaxial with the fibre and connected at the two ends to the doped waveguide and with the other core which is off-centre and cut off at the ends.
- 55
47. An optical amplifier according to claim 31, characterized in that said filtering means consists of an interferential filter used in reflection.

and for attenuating by a value higher than a predetermined minimum the spontaneous emission at the wavelengths outside said intervals,

5 - a second optical rare-earth-doped waveguide (120) fed, through coupling means (121), with pumping radiation at a pumping wavelength from a second pumping source (122) and with signals from said first optical rare-earth-doped waveguide,

wherein said predetermined position, said given attenuation amount of the differential-attenuation means and said predetermined attenuation minimum of the filtering means are selected in such a functional relation with respect to each other that power variations in one of the signals input to the amplifier within a range of 20 dB involve variations of the output power included in a range not greater than 3 dB.

10

58. An optical telecommunication system according to claim 57, characterized in that power variations in one of the signals input to the amplifier within a range of 20 dB involve variations of the output power included in a range not greater than 2 dB.

15

59. An optical telecommunication system according to claim 57, characterized in that said given attenuation amount of the differential-attenuation means is higher than $5 \text{ dB} \pm 1 \text{ dB}$.

60. An optical telecommunication system according to claim 57, characterized in that said filtering means includes a distributed Bragg reflection filter.

20

61. Method for transmitting optical signals on an optical communication line including cascade active-fibre optical amplifiers (45, 45', 45'', 45'''), comprising

25

- feeding at least two optical signals with different wavelengths in said optical communication line,
 - feeding pumping radiation in each of said active-fibre optical amplifiers, characterized in that it comprises:
 - filtering at least a portion of the spontaneous emission at a first predetermined position along the active fibre of at least one of said optical amplifiers,
 - attenuate said optical signals with respect to said pumping radiation, at a second predetermined position along the active fibre of said at least one optical amplifier, by a value greater than a given amount,
- 30 wherein said first and second predetermined positions and said given attenuation amount are operatively selected in such a way that power variations in one of the signals input to said amplifier within a range of 20 dB involve variations of the power of said signal at the output of said amplifier included in a range not greater than 3 dB.

35

62. Method for transmitting optical signals according to claim 61, characterized in that said first predetermined position coincides with said second predetermined position.

40

63. Method for transmitting optical signals according to claim 61, characterized in that said operation of filtering at least a portion of the spontaneous emission includes removing the spontaneous emission in the bands comprised between each couple of contiguous wavelengths of said communication signals.

45

50

55

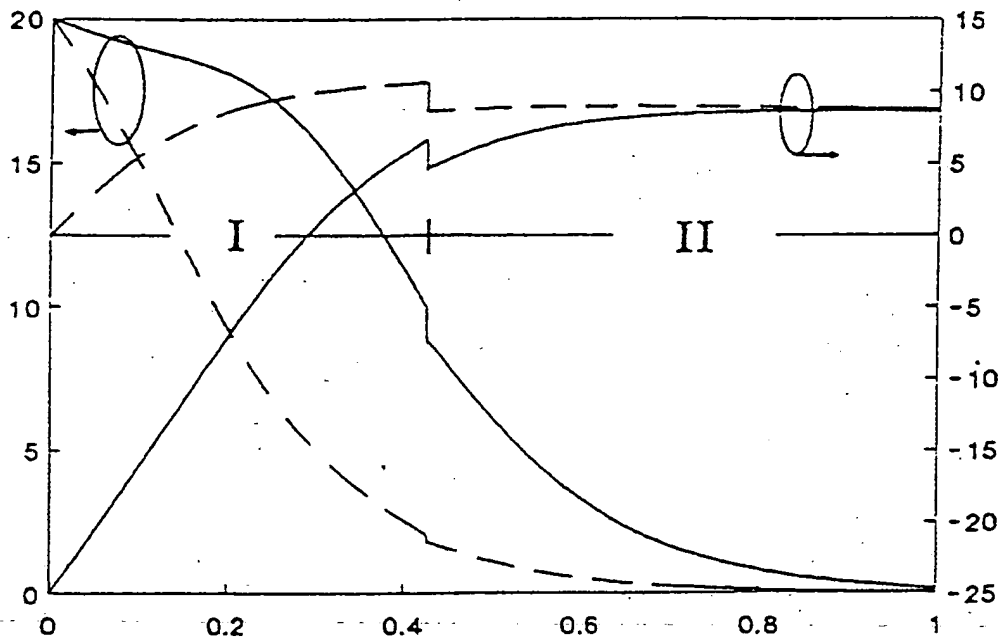

fig. 2

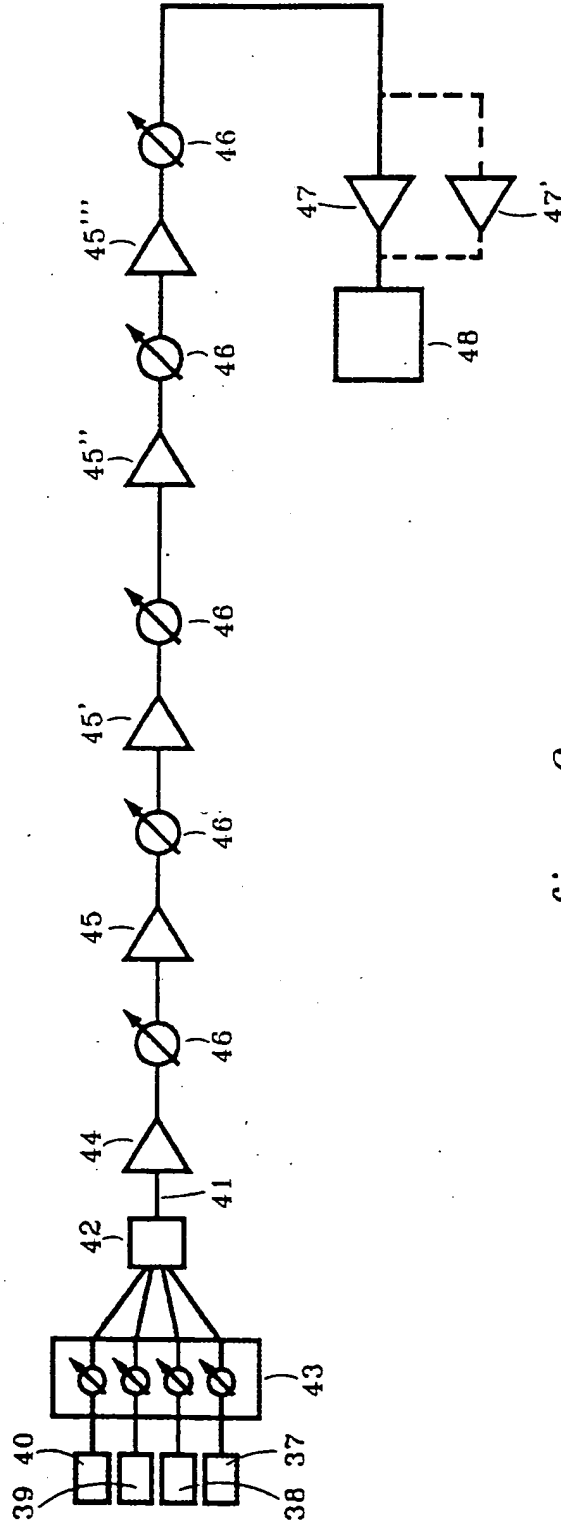

fig. 6

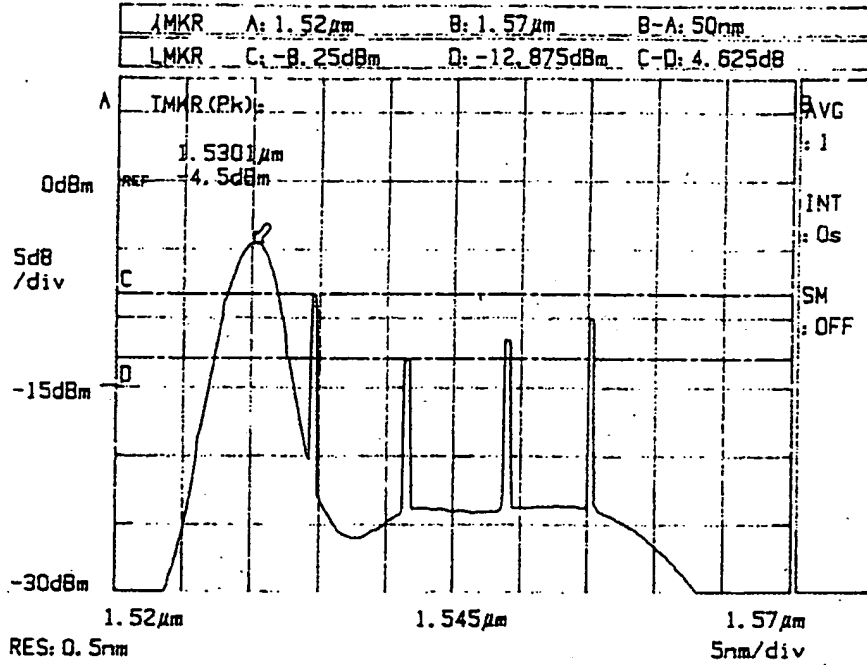

fig. 8A

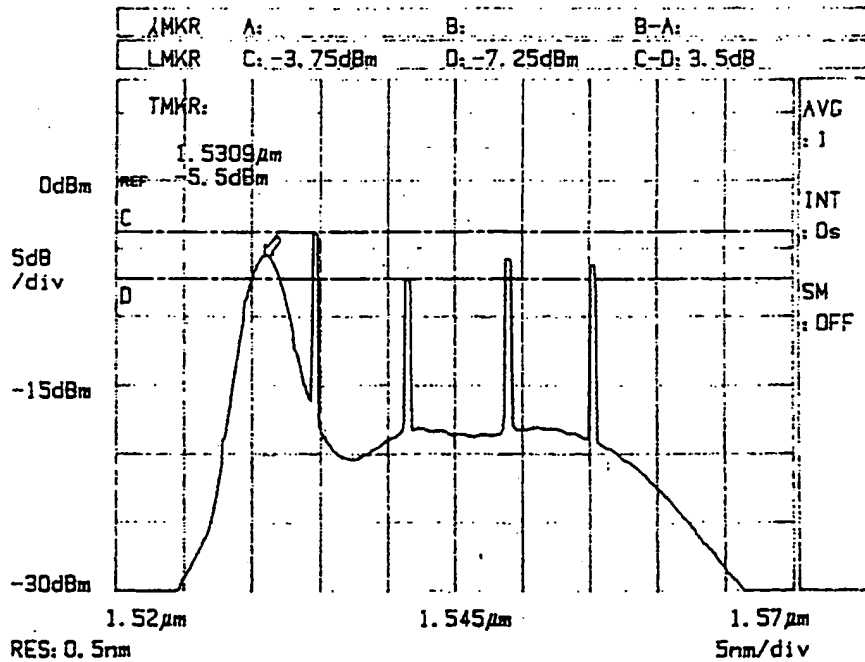

fig. 8B

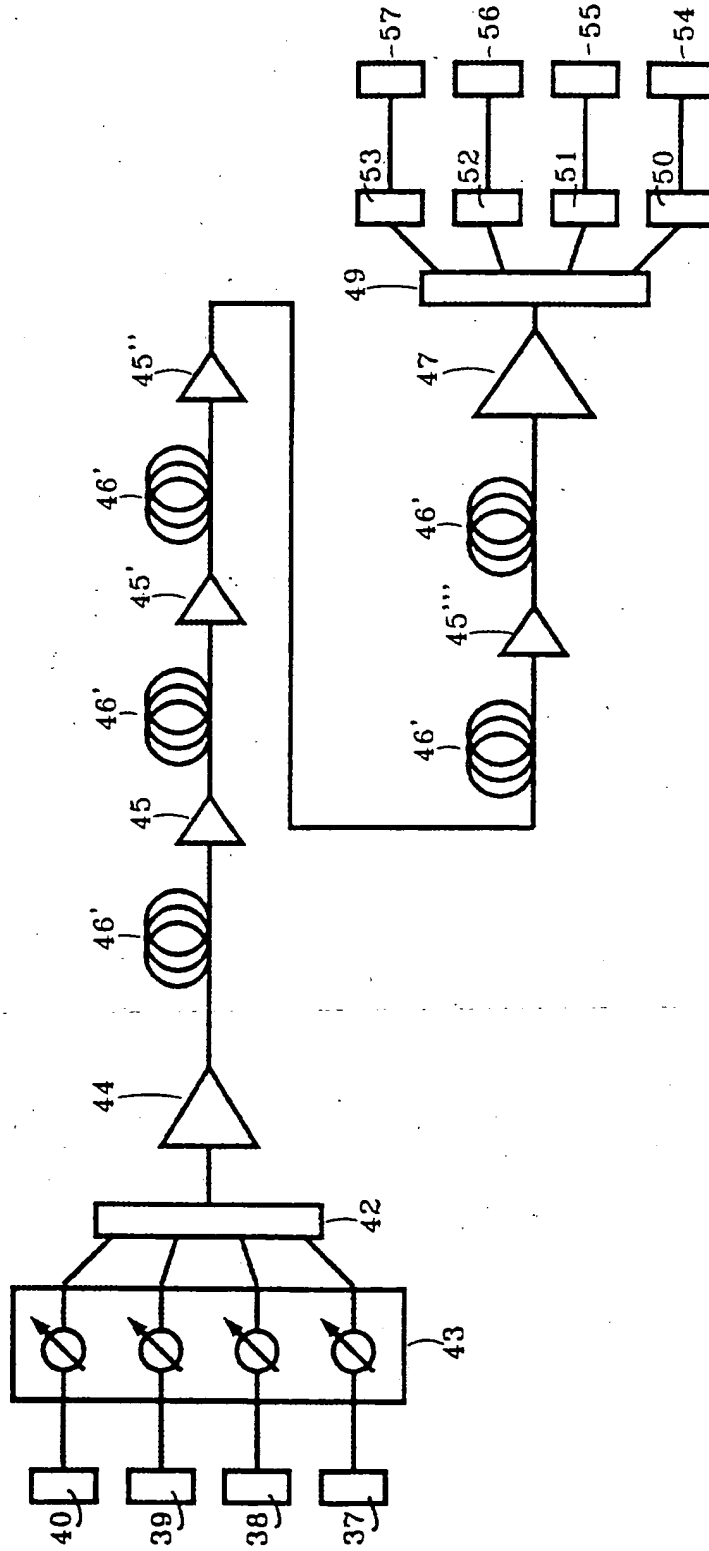

fig. 11

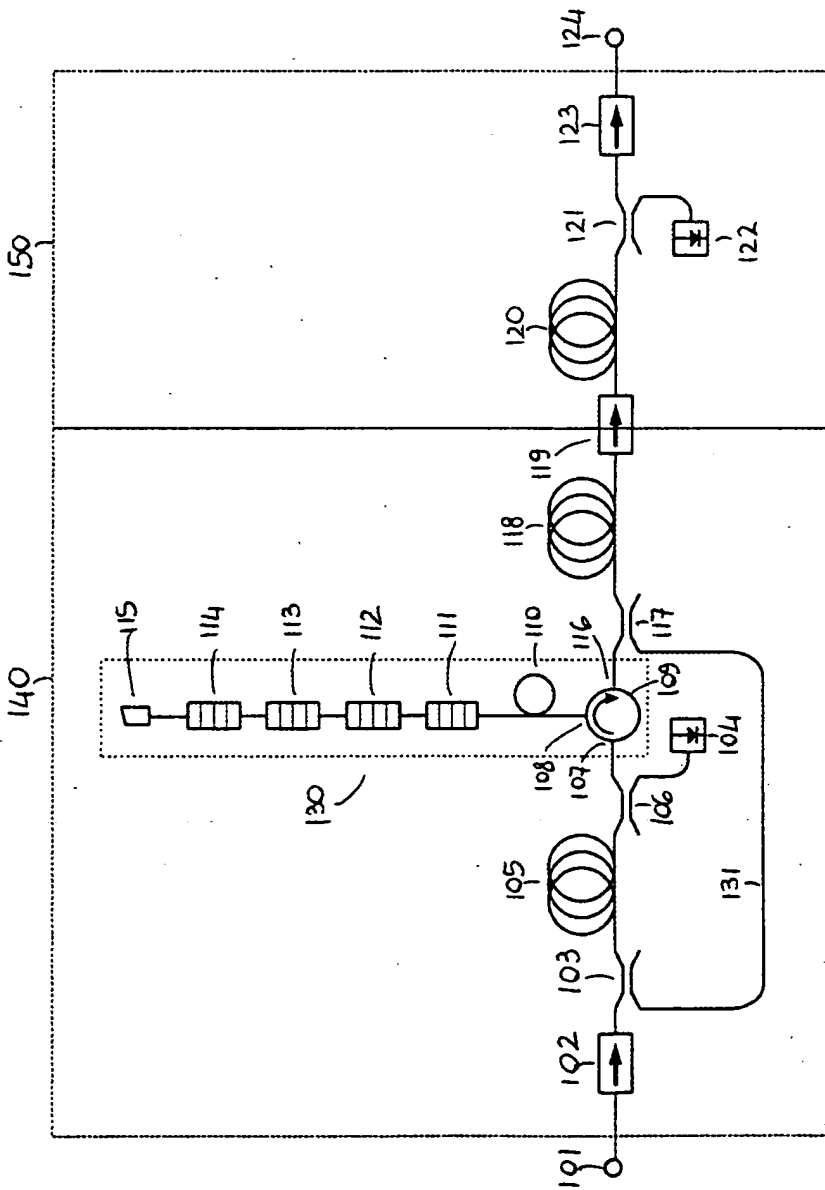

Fig 13



European Patent
Office

EUROPEAN SEARCH REPORT

Application Number
EP 95 11 1505

DOCUMENTS CONSIDERED TO BE RELEVANT			
Category	Citation of document with indication, where appropriate, of relevant passages	Relevant to claim	CLASSIFICATION OF THE APPLICATION (Int.Cl.6)
Y	IEICE TRANSACTIONS ON COMMUNICATIONS, vol.E77B, no.4, April 1994, TOKYO JP pages 454 - 460 SEIKAI ET AL 'Studies on optimisation of an Erbium-doped fibre amplifier suitable for an optical transmission line containing an amplifier repeater' * page 455, left column, line 4 - line 9 * * page 456, left column, line 22 - line 27; figures 1,3 *	57-59	
Y	EP-A-0 463 771 (AT&T) * column 3, line 42 - column 4, line 16 * * column 4, line 29 - line 34 * * column 6, line 54 - column 7, line 1 * * figure 1 *	61	
A		1-60,62, 63	
A	GB-A-2 161 612 (STC) * abstract; figure 4 *	57-60	
			TECHNICAL FIELDS SEARCHED (Int.Cl.6)
The present search report has been drawn up for all claims			
Place of search	Date of completion of the search	Examiner	
THE HAGUE	20 September 1995	Williams, M.I.	
CATEGORY OF CITED DOCUMENTS			
X : particularly relevant if taken alone Y : particularly relevant if combined with another document of the same category A : technological background O : non-written disclosure P : intermediate document		T : theory or principle underlying the invention E : earlier patent document, but published on, or after the filing date D : document cited in the application L : document cited for other reasons & : member of the same patent family, corresponding document	

EPO FORM 1500 (03/92) (P/0600)